

# Data Sheet



Article number: 20166634

Description: E+G Cabinet U-handle GN 426-AL-20-300-SW

## Measures

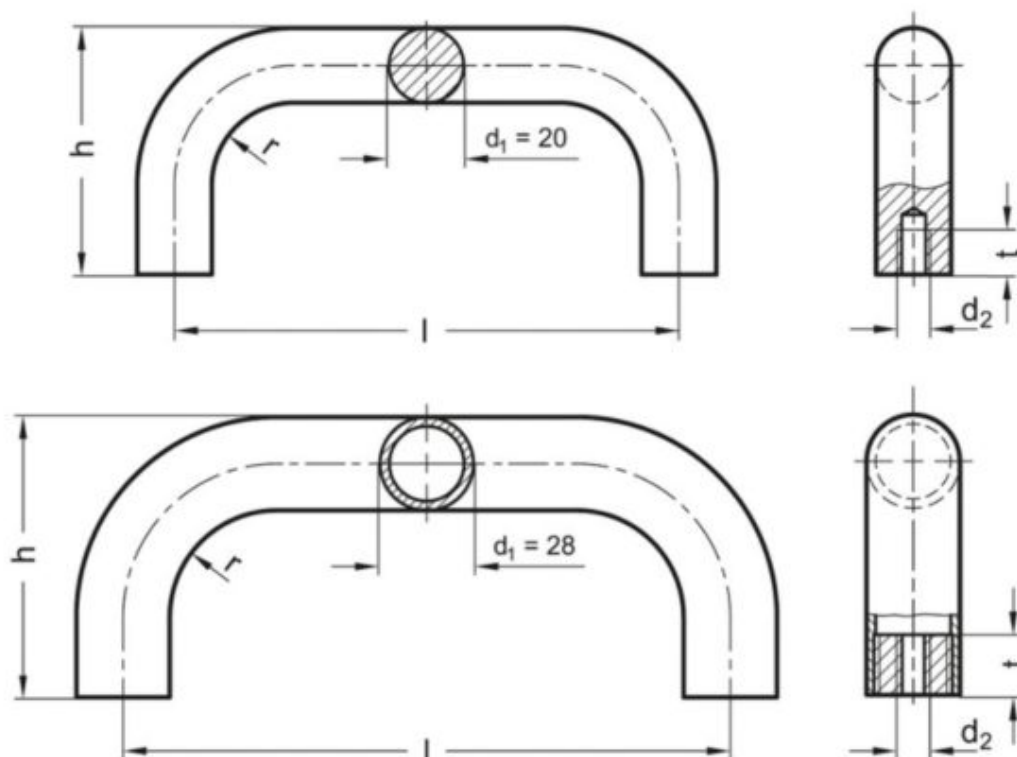

$d_1$	= 20
$d_2$	= M8
$h$	= 68
$l$	= 300
$r$	= 22
$t_{min}$	= 15